

SD Series - D-Sub 90°
9,40mm / .370" „Euro Style“ Footprint

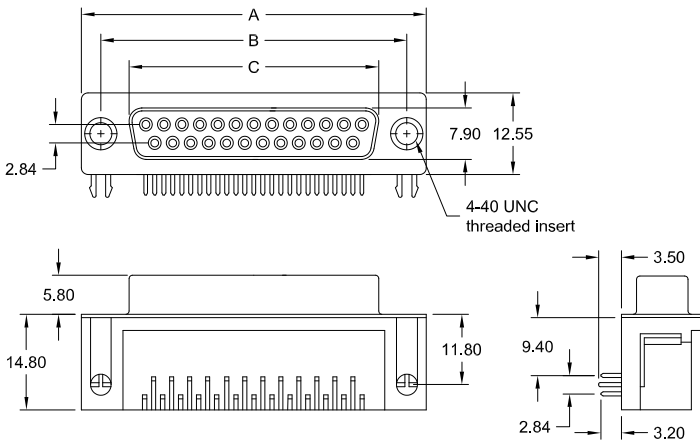

female



PCB hole layout on page 29

No. of contacts	Dimension		
	A	B	C
009	30.81	24.99	16.33
	1.213	.984	.643
015	39.14	33.32	24.66
	1.541	1.312	.971
025	53.04	47.04	38.38
	2.088	1.852	1.511
037	69.32	63.50	54.84
	2.729	2.500	2.159

Ordering Code

SDF - xxx - M900 - 55 / XX
 No. of contacts Option

Plating: -55 = gold

General Specification page 72

male

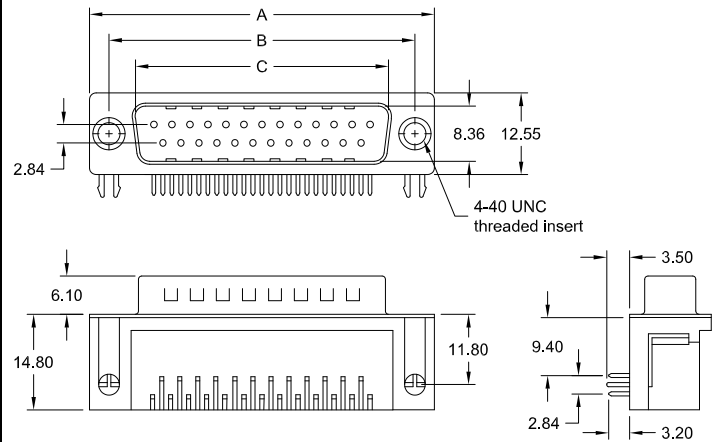

PCB hole layout on page 29

No. of contacts	Dimension		
	A	B	C
009	30.81	24.99	16.92
	1.213	.984	.666
015	39.14	33.32	25.25
	1.541	1.312	.994
025	53.04	47.04	38.96
	2.088	1.852	1.534
037	69.32	63.50	55.42
	2.729	2.500	2.182

Ordering Code

SDM - xxx - M900 - 55 / XX
 No. of contacts Option

Plating: -55 = gold

Options

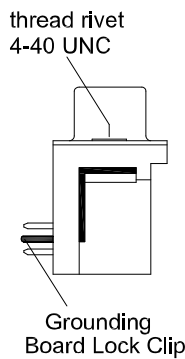

N

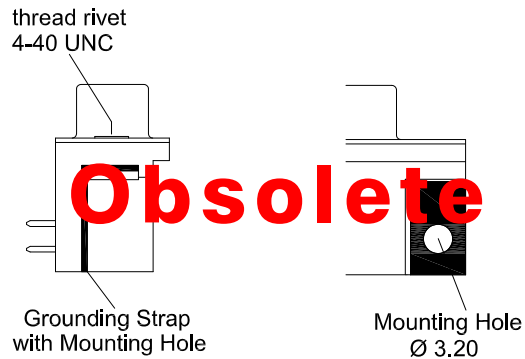

H

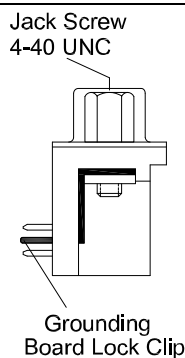

NJ

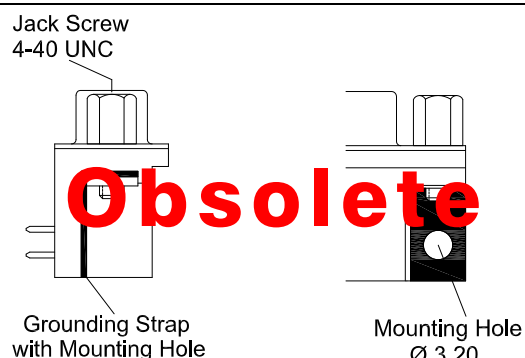

HJ

N900 & M900 Type

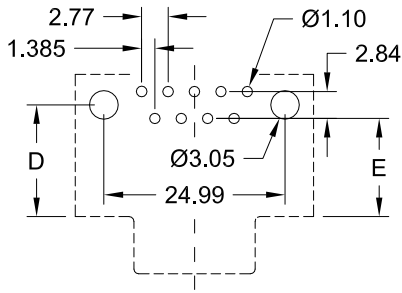

9-pin

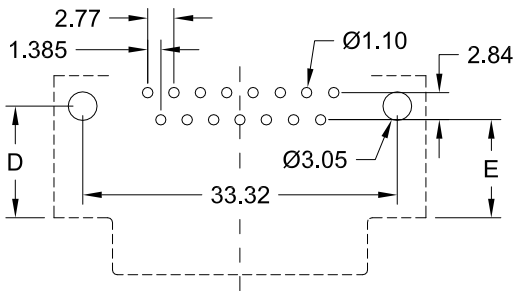

15-pin

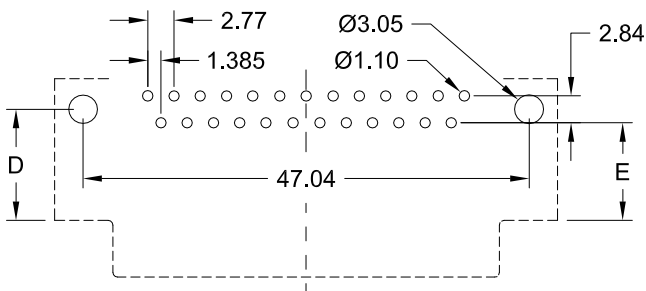

25-pin

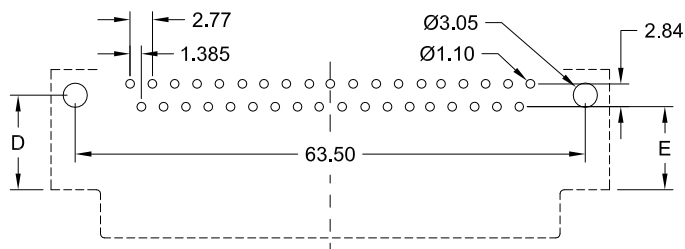

37-pin

L900 Type

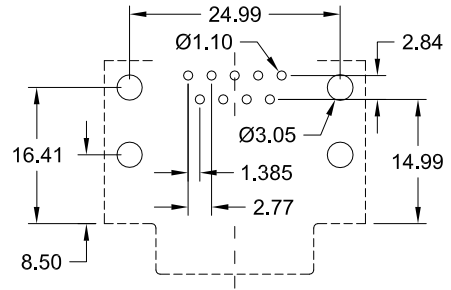

9-pin

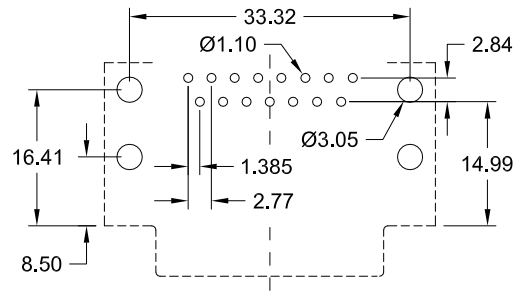

15-pin

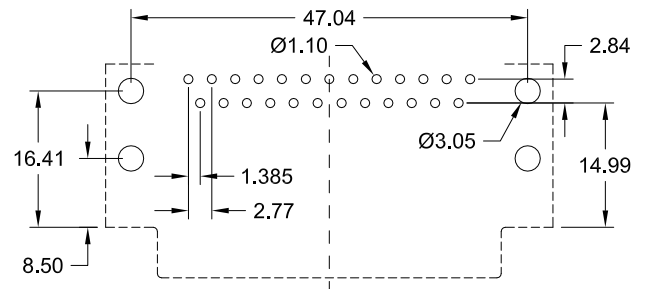

25-pin

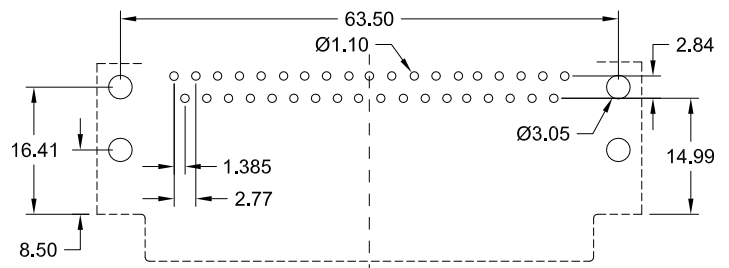

37-pin

D-Sub Type	Dim. "D" ±0.25/±.010	Dim. "E" ±0.25/±.010
N 900	<u>9.50</u> .374	<u>8.08</u> .318
M 900	<u>11.70</u> .461	<u>10.30</u> .406



mechanical data

Mating force per contact	≤ 3,4 N
Unmating force per contact	≥ 0,2 N
Temperature range	-55° C to +105° C
Processing temperature wave solder (solder bath)	+250°C +0/-5°C for 10sec.
Processing temperature SMT and “pin in paste”	+250°C +0/-5°C for 10sec.
Moisture absorption from air 50% rh	0,10%
IDC Connector types accept AWG 26 or AWG 28 standard wire	

materials and plating (RoHS compliant)

Insulator for wave solder technology, standard black - PC 99 colourful insulator	thermoplastic glassfilled UL 94V – 0 Yellowish brown - Pantone # 131C 15-pos. female Burgundy - Pantone # 235C 25-pos. female Teal - Pantone # 322C 9-pos. male Blue - Pantone # 661C HD 15-pos.
female	
Insulator for SMT and “Pin-In-Paste”	Nylon UL 94V-0
Shell	Steel, Ni plated
Bracket	Brass, tin plated
Male contact - plating	Copper Alloy (Standard; others on request) -95 = solder side Sn; contact side Au over Ni -55 = solder and contact side Au over Ni
Female contact - plating	Copper Alloy (Standard; others on request) -95 = solder side Sn; contact side Au over Ni -55 = solder and contact side Au over Ni
D-Sub Accessories (page 70) plating	-NN = Ni

electrical data

max. Current rating	5 A/25°C 3 A/70°C (High Density types 3A / IDC types 1A)
Operating voltage	250 V
Test voltage between contacts	1000 V / 50/60 Hz / 1 Minute
Test voltage between shell and contacts	1000 V / 50/60 Hz / 1 Minute
Resistance between mated contacts	< 30 m Ω
Insulation resistance	≥ 1000 M Ω at 500V DC
Dielectric strength	1000 V AC min. for 1 Minute
Volume resistivity	10 ¹⁶ Ω cm (ASTM-D 257)

available performance classes

E-tec D-Sub connectors comply with Performance Class 3 (min. 50 contact cycles).
Please contact E-tec first for availability of Performance Class 2 (min. 200 contact cycles) and 1 (min. 500 contact cycles)

D-Sub with Filter (ferrite)

Frequency range	10 - 300 MHz
Impedance	5 MHz - 15 Ω
	25 MHz - 30 Ω
	100 MHz - 50 Ω
	300 MHz - 75 Ω

